

A description based on languages of the final non-deterministic automaton

A. Ballester-Bolinches* E. Cosme-Llópez*
R. Esteban-Romero*[‡]

1st June 2015

Abstract

The study of the behaviour of non-deterministic automata has traditionally focused on the languages which can be associated to the different states. Under this interpretation, the different branches that can be taken at every step are ignored. However, we can also take into account the different decisions which can be made at every state, that is, the branches that can be taken, and these decisions might change the possible future behaviour. In this case, the behaviour of the automata can be described with the help of the concept of bisimilarity. This is the kind of description that is usually obtained when the automata are regarded as labelled transition systems or coalgebras.

Contrarily to what happens with deterministic automata, it is not possible to describe the behaviour up to bisimilarity of states of a non-deterministic automaton by considering just the languages associated to them. In this paper we present a description of a final object for the category of non-deterministic automata, regarded as labelled transition systems, with the help of some structures defined in terms of languages. As a consequence, we obtain a characterisation of bisimilarity of states of automata in terms of languages and a method to minimise non-deterministic automata with respect to bisimilarity of states. This confirms that languages can be considered as the natural objects to describe the behaviour of automata.

*Departament d'Àlgebra, Universitat de València; Dr. Moliner, 50; E-46100 Burjassot (València), Spain, email: Adolfo.Ballester@uv.es, Enric.Cosme@uv.es, Ramon.Esteban@uv.es

[†]Institut Universitari de Matemàtica Pura i Aplicada, Universitat Politècnica de València; Camí de Vera, s/n; E-46022 València, Spain, email: resteban@mat.upv.es

[‡]Corresponding author

Mathematics Subject Classification (2010): 68Q70, 68Q45, 68Q55, 18B20

Keywords: non-deterministic automaton, formal language, coalgebra, bisimilarity, final automaton.

1 Introduction

The aim of this paper is to present a description of the final object of the category of non-deterministic automata, regarded as labelled transition systems, by means of languages. Our description emphasises the role of languages as natural objects to describe the behaviour of automata.

In this paper we will use the terminology of category theory. We will assume the reader to be familiar with the basic concepts of category theory, as categories, functors, and final or terminal objects. The reader is referred to [20] for more information about category theory.

We can assign to every state of an automaton an associated language, consisting of all words which send this state to a final or terminal state. Traditionally, many authors have considered as the behaviour of a state of an automaton simply its associated language. Under this point of view, the different decisions that may be taken from each state are ignored. However, we can take into account the different branches or decisions that may be taken at every state. They might change the future behaviour of the automaton. From this point of view, automata are regarded as labelled transition systems or coalgebras for suitable endofunctors on the category **Set**. In this scope, the idea of the behaviour of the states of the coalgebra is related to the notion of bisimilarity, a concept originated in the field of concurrency (its precise definition will be given in Section 2, see Definition 2.13). We can say that two states have the same behaviour when they are bisimilar. Under very general hypotheses, which hold for automata, when a category of coalgebras possesses a final object, two states are bisimilar if and only if both states have the same image by the unique homomorphism into the final object. This motivates the interest in studying the final objects in some categories of coalgebras, like automata.

Up to now, most known descriptions of final coalgebras are of a very general theoretical nature or are given as a quotient of a coalgebra by the bisimilarity relation. We will present some of them in Section 3. When they are applied to the functor $\mathcal{N} = 2 \times \mathcal{P}_\omega(\text{Id})^A$ associated to non-deterministic automata, it seems that they do not give a clear idea of the role of languages, which are incontestably a central notion in this theory, in the final automaton. Hence the question of whether languages can be used to describe

the behaviour of non-deterministic automata as labelled transition systems remains open. The aim of this paper is to give a positive answer to this question. This also allows us to characterise bisimilarity of states of automata in terms of languages, which has been a long-standing unsolved problem in this theory.

We have done our best to keep our paper self-contained. Accordingly, Section 2 covers several topics of formal languages, automata, and coalgebras. Our main result is presented in Section 3. We conclude the paper by justifying why our description is the most natural one and by establishing some questions for future research.

2 Automata and formal languages

An introduction to the classical theory of finite automata can be found in [15]. Since our treatment of automata differs from the usual with respect to the initial state, we have preferred to recall first some basic concepts:

Definition 2.1. An *alphabet* is a finite non-empty set, whose elements are called *letters*.

Definition 2.2. A *finite word* over an alphabet A is either the empty word ϵ or a sequence $a_1a_2 \dots a_r$ of letters of A . The set of all finite words over A is denoted by A^* .

Note that A^* can be regarded as the free monoid on the set A , where the multiplication in A^* is defined as the juxtaposition of words. In the rest of the paper, we will only consider finite words.

Definition 2.3. A *language* (or *formal language*) over an alphabet A is a subset of A^* , that is, a set of words over A .

Definition 2.4 (operations with languages). If L , L_1 , and L_2 are languages, we define:

1. the *sum* $L_1 + L_2 = L_1 \cup L_2$ of L_1 and L_2 , which coincides with the set-theoretical union of L_1 and L_2 ,
2. the *product* $L_1L_2 = \{w_1w_2 \mid w_1 \in L_1, w_2 \in L_2\}$ of L_1 and L_2 , composed by the words which are the result of concatenating one word of L_1 and one word of L_2 , and
3. the *Kleene star* $L^* = \bigcup_{n \geq 0} L^n$ of L , where $L^0 = \{\epsilon\}$, $L^1 = L$ and $L^{n+1} = L^nL$ for $n \in \mathbb{N}$.

Definition 2.5. The set of all regular languages \mathcal{R} is the smallest set of languages containing all finite languages and which is closed under taking sums, products, and Kleene stars.

It is usual to identify a letter a with the language $\{a\}$. With this criterion, we can identify the regular languages with the so-called *regular expressions*.

Regular languages are closely connected with finite automata. In this paper we will deal with the next generalisations of the notion of finite automata, in which infinite sets of states are allowed.

Definition 2.6. A *non-deterministic automaton* (respectively, a *deterministic automaton*, a *partial deterministic automaton*) is a quadruple $\mathcal{A} = (S, A, S_f, \delta)$ in which S is a set (not necessarily finite) whose elements are called *states*, A is an alphabet, S_f is a subset of S whose members will be called *final states* or *accepting states*, and the function $\delta: S \times A \rightarrow \mathcal{P}_\omega(S)$ (respectively, the function $\delta: S \times A \rightarrow S$ or the partial function $\delta: S \times A \rightarrow S$), called the *transition function*, assigns to each letter and to each state a *finite* set of states (respectively, a state, at most one state). When the set of states is finite we say that the corresponding automaton is *finite*.

Here $\mathcal{P}_\omega(S)$ denotes the set of all finite subsets of the set S . The finiteness restriction on the set of possible transitions from a given state is imposed here to ensure the existence of a final automaton.

It is also common to consider an initial state or a set of initial states in the study of finite automata, but we will not need it in our development, because eventually all states might play the role of the initial state. A deterministic automaton can be considered as a non-deterministic automaton by identifying an image s' of a state under the transition function with the singleton $\{s'\}$. Hence, unless otherwise stated, the word *automaton* will be used as a synonymous of *non-deterministic automaton*. We will represent with an arrow $s_1 \xrightarrow{a} s_2$ the fact that $s_2 \in \delta(s_1, a)$.

The transition function of an automaton can be extended to a function $\hat{\delta}: S \times A^* \rightarrow \mathcal{P}_\omega(S)$ in the usual way: $\hat{\delta}(s, \epsilon) = \{s\}$, where ϵ is the empty word; if $w \in A^*$ and $a \in A$, $\hat{\delta}(s, wa) = \bigcup \{\delta(t, a) \mid t \in \hat{\delta}(s, w)\}$. In the case of deterministic automata, the value of this function is always a singleton. We generalise the notion of language accepted by an automaton with an initial state in the following way:

Definition 2.7. Given an automaton $\mathcal{A} = (S, A, S_f, \delta)$ and a state $s \in S$, the set $L_{\mathcal{A},s} = \{w \in A^* \mid \hat{\delta}(w, s) \cap S_f \neq \emptyset\}$ is called the *language accepted* or *recognised* by the automaton \mathcal{A} starting from the state s .

We will write L_s instead of $L_{\mathcal{A},s}$ if \mathcal{A} is understood. It is well-known that the regular languages coincide with the languages recognised by finite automata (either non-deterministic, deterministic, or partial deterministic).

All these types of automata and other labelled transition systems can be considered as particular cases of a more general structure, \mathcal{F} -coalgebras, where \mathcal{F} is an endofunctor of a category. We will recall here the basic concepts of coalgebras. For a more detailed introduction to the theory of coalgebras, the reader is referred to the works of Adámek [2] or Rutten [21, 22]. We will only consider endofunctors of the category **Set** of all sets and functions between sets.

Definition 2.8. Let \mathcal{F} be an endofunctor of the category **Set** of all sets and functions. An \mathcal{F} -coalgebra or \mathcal{F} -system is a pair (S, α_S) consisting of a set S and a function $\alpha_S: S \rightarrow \mathcal{F}S$. The set S is called the *carrier* of the coalgebra and its elements are called *states*. The function α_S receives the name of \mathcal{F} -transition structure of the system. When α_S is understood, we use S instead of (S, α_S) .

In the following, we will denote by $2 = \{0, 1\}$ a set of two elements and by $1 = \{*\}$ a singleton. The identity functor will be denoted by Id .

Examples 2.9 (see also [27]). A deterministic automaton (S, A, S_f, δ) can be regarded as a \mathcal{D} -coalgebra for the functor $\mathcal{D} = 2 \times \text{Id}^A$. Here

$$\alpha_S(s) = (o_S(s), f_S(s)),$$

where $o_S(s) = 1$ if $s \in S_f$, $o_S(s) = 0$ if $s \notin S_f$, and $f_S(s): A \rightarrow S$ is defined by $f_S(s)(a) = \delta(s, a)$. In a similar way, a partial deterministic automaton (S, A, S_f, δ) can be regarded as a \mathcal{G} -coalgebra for the functor $\mathcal{G} = 2 \times (1 + \text{Id})^A$, where $\alpha_S(s) = (o_S(s), f_S(s))$, with $o_S(s) = 1$ if $s \in S_f$, $o_S(s) = 0$ if $s \notin S_f$, and $f_S(s): A \rightarrow 1 + S$ is defined by $f_S(s)(a) = \delta(s, a)$ if $\delta(s, a)$ is defined and $f_S(s)(a) = *$ otherwise. Note that the functor used here differs from the one used in [27], which is $\mathcal{F} = (1 + \text{Id})^A$, because we are using a slightly different definition of partial deterministic automata: theirs do not have accepting states. However, our functor coincides with the functor used in [26]. Finally, a non-deterministic automaton (S, A, S_f, δ) is an \mathcal{N} -coalgebra for the functor $\mathcal{N} = 2 \times (\mathcal{P}_\omega(\text{Id}))^A$. The transition structure α_S is given by $\alpha_S(s) = (o_S(s), f_S(s))$, with $o_S(s) = 1$ if $s \in S_f$, $o_S(s) = 0$ if $s \notin S_f$, and $f_S(s): A \rightarrow \mathcal{P}(S)$ given by $f_S(s)(a) = \delta(s, a)$.

Definition 2.10. Let (S, α_S) and (T, α_T) be two \mathcal{F} -coalgebras, where \mathcal{F} is an endofunctor of **Set**. A function $f: S \rightarrow T$ is a *homomorphism* of \mathcal{F} -coalgebras or an \mathcal{F} -homomorphism if $(\mathcal{F}f) \circ \alpha_S = \alpha_T \circ f$, in other words,

when the following diagram is commutative:

$$\begin{array}{ccc} S & \xrightarrow{f} & T \\ \alpha_S \downarrow & & \downarrow \alpha_T \\ \mathcal{F}S & \xrightarrow{\mathcal{F}f} & \mathcal{F}T \end{array}$$

In order to make the notation lighter, we will follow the standard convention of using the same symbol f to denote a homomorphism and its underlying function.

We can consider the category of \mathcal{F} -coalgebras, whose objects are \mathcal{F} -coalgebras and whose morphisms are \mathcal{F} -coalgebra homomorphisms.

Example 2.11. A homomorphism between the automata (S, A, S_f, δ) and (S', A, S'_f, δ') is defined by a function $\phi: S \rightarrow S'$ such that $s \in S_f$ if and only if $\phi(s) \in S'_f$ and $\delta'(\phi(s), a) = \{\phi(s') \mid s' \in \delta(s, a)\}$. Hence we can consider the category of automata over an alphabet A .

In this paper we will give a description of a final automaton in such a way that the homomorphism from an automaton \mathcal{A} to the final automaton will be given in terms of some structures related to the languages associated with each of the states of the automaton. These structures will be useful to characterise bisimilarity, a concept originated from concurrency theory in computer science and which is very relevant in the framework of coalgebras.

Definition 2.12. Let \mathcal{F} be an endofunctor of **Set**. Let (S, α_S) and (T, α_T) be two \mathcal{F} -coalgebras. A subset $Z \subseteq S \times T$ of the cartesian product of S and T is called an \mathcal{F} -bisimulation if there exists a structure function $\gamma: Z \rightarrow \mathcal{F}Z$ such that the projections from Z to S and T are \mathcal{F} -coalgebra homomorphisms. In other words, (Z, γ) makes the following diagram commute:

$$\begin{array}{ccccc} S & \xleftarrow{\pi_S} & Z & \xrightarrow{\pi_T} & T \\ \alpha_S \downarrow & & \exists \downarrow \gamma & & \downarrow \alpha_T \\ \mathcal{F}S & \xleftarrow{\mathcal{F}\pi_S} & \mathcal{F}Z & \xrightarrow{\mathcal{F}\pi_T} & \mathcal{F}T \end{array}$$

If (S, α_S) and (T, α_T) are equal, we simply speak of a bisimulation on S .

Definition 2.13. Two states $s \in S$ and $t \in T$ are said to be *bisimilar* when there exists a bisimulation R between S and T such that $\langle s, t \rangle \in R$.

Example 2.14. Let $\mathcal{A} = (S, A, S_f, \delta)$ and $\mathcal{A}' = (T, A, T_f, \delta')$ be two automata over the same alphabet A . A relation $R \subseteq S \times T$ is a bisimulation between \mathcal{A} and \mathcal{A}' if and only if for all $\langle s, t \rangle \in R$, the following three conditions are satisfied:

1. $s \in S_f$ if and only if $t \in T_f$,
2. for all $s' \in S$, if $s' \in \delta'(s, a)$, then there exists $t' \in T$ such that $t' \in \delta'(t, a)$ and $\langle s', t' \rangle \in R$, and
3. for all $t' \in T$, if $t' \in \delta'(t, a)$, then there exists $s' \in S$ such that $s' \in \delta(s, a)$ and $\langle s', t' \rangle \in R$.

Intuitively, we can say that two states of two \mathcal{F} -coalgebras are bisimilar when they are not distinguishable from the observer point of view, in other words, when the “observable behaviours” of both automata from both states are the same. This can be used to introduce a semantics in \mathcal{F} -coalgebras (see [22, 23]). The notion of bisimulation has been studied from a more general point of view in [17] with the help of open maps.

The following technical notion gives a condition which is satisfied by the functors we are interested in. We present it because it is used in the proofs of some of the theorems about bisimulations.

Definition 2.15. We say that a *weak pullback* of two functions $f: X \rightarrow Z$ and $g: Y \rightarrow Z$ in **Set** is a triple (P, π_X, π_Y) such that P is a set, $\pi_X: P \rightarrow X$ and $\pi_Y: P \rightarrow Y$ are functions such that $f \circ \pi_X = g \circ \pi_Y$ and for each triple (P', π'_X, π'_Y) satisfying the previous conditions, there is a function $p': P' \rightarrow P$, not necessarily unique, such that $\pi_X \circ p' = \pi'_X$ and $\pi_Y \circ p' = \pi'_Y$. If the function p' is unique, we speak of a *pullback*. A functor $\mathcal{F}: \mathbf{Set} \rightarrow \mathbf{Set}$ preserves (weak) pullbacks if for every (weak) pullback (P, π_X, π_Y) of (f, g) , the triple $(\mathcal{F}P, \mathcal{F}\pi_X, \mathcal{F}\pi_Y)$ is a (weak) pullback of $(\mathcal{F}f, \mathcal{F}g)$.

In the following, *we will assume that \mathcal{F} is an endofunctor of **Set** which preserves weak pullbacks*. This assumption holds for the functor $\mathcal{F} = \mathcal{N}$ corresponding to non-deterministic automata, as well as for all other functors presented in this paper (see [22] for more details about this assumption).

The following result summarises some of the properties of bisimulations between \mathcal{F} -coalgebras (see [22]). The second statement depends on the fact that \mathcal{F} preserves weak pullbacks.

Theorem 2.16. *Let (S, α_S) and (T, α_T) be two \mathcal{F} -coalgebras.*

1. *The union of a family of bisimulations between (S, α_S) and (T, α_T) is a bisimulation.*
2. *The relational composition of two bisimulations between (S, α_S) and (T, α_T) is a bisimulation.*
3. *The equality relation in (S, α_S) is a bisimulation in (S, α_S) .*

4. *The relational inverse of a bisimulation between (S, α_S) and (T, α_T) is a bisimulation between (T, α_T) and (S, α_S) .*

As a consequence, there exists a largest bisimulation between two automata over the same alphabet, namely the union of all bisimulations between them.

Theorem 2.17 (see [22, Theorem 2.5]). *Let (S, α_S) and (T, α_T) be two \mathcal{F} -coalgebras. A function $f: S \rightarrow T$ induces an \mathcal{F} -homomorphism between (S, α_S) and (T, α_T) if and only if its graph $G(f) = \{\langle s, f(s) \rangle \mid s \in S\}$ is a bisimulation between (S, α_S) and (T, α_T) .*

There has been a big interest in studying the existence and descriptions of final \mathcal{F} -coalgebras for a functor \mathcal{F} . Let us recall some properties of final coalgebras.

Theorem 2.18 ([16, Lemma 6.4]). *Let \mathcal{F} be an endofunctor on **Set**.*

1. *If there exist final \mathcal{F} -coalgebras, then all of them are isomorphic.*
2. (Lambek's lemma [19]) *If (T, α_T) is a final \mathcal{F} -coalgebra, then the function $\alpha_T: T \rightarrow \mathcal{F}T$ has an inverse, in other words, α_T is an isomorphism.*

The last condition is sometimes expressed in the following terms: a final \mathcal{F} -coalgebra (T, α_T) is a fixed point for the functor \mathcal{F} .

We cannot ensure the existence of final \mathcal{F} -coalgebras for every possible endofunctor of **Set**. For example, for the functor $\mathcal{F} = \mathcal{P}$ defined by $\mathcal{F}S = \mathcal{P}(S)$, the set of all subsets of S , and for a function $f: S \rightarrow T$, $\mathcal{F}f(W) = \{f(w) \mid w \in W\}$ for every $W \in \mathcal{P}(S)$, there cannot be any final \mathcal{P} -coalgebra: by a well-known theorem of Cantor, the cardinal of S is strictly smaller than the cardinal of $\mathcal{P}(S)$. This is the reason we are imposing the finiteness in the set of transitions and we are working with \mathcal{P}_ω , for which all infinite sets are fixed points.

Theorem 2.19 (Rutten and Turi [23], see [22, Theorem 9.2]). *Every bisimulation of a final \mathcal{F} -coalgebra (T, α_T) is contained in the diagonal*

$$\Delta_T = \{\langle t, t \rangle \mid t \in T\}.$$

In other words, two bisimilar states are equal.

An \mathcal{F} -coalgebra satisfying the above condition (two bisimilar states are equal) is called *simple*.

A way to check bisimilarity between two states of two \mathcal{F} -coalgebras is to check whether both states have the same images under the unique homomorphisms into the final \mathcal{F} -coalgebra. This is a consequence of the following result, which is in essence [22, Theorem 4.3] (see also [12, Theorem 5.1, (i) implies (ii)]) and depends on the fact that the functor \mathcal{F} preserves weak pullbacks. We present a proof here for completeness.

Theorem 2.20. *Let (T, α_T) be a final \mathcal{F} -coalgebra. Two states s and s' of two \mathcal{F} -coalgebras (S, α_S) and $(S', \alpha_{S'})$, respectively, are bisimilar if and only if they have the same image under the unique homomorphisms from (S, α_S) and $(S', \alpha_{S'})$ to (T, α_T) .*

Proof. Denote by $!$ and $'$ the homomorphisms from S and S' to T , respectively. Suppose that $!(s) = '(s') = t$, then $\langle s, t \rangle \in R = G(!)$ and $\langle s', t \rangle \in R' = G(')$, and $G(!)$ and $G(')$ are bisimulations by Theorem 2.17. Hence $\langle s, s' \rangle$ belongs to the bisimulation $(R')^{-1} \circ R$ by Theorem 2.16 and so s and s' are bisimilar.

Conversely, suppose that s and s' are bisimilar, that is, $\langle s, s' \rangle$ belongs to a bisimulation V . Denote by $R = G(!)$ and $R' = G(')$ the graphs of $!$ and $'$, respectively. By Theorem 2.17, R and R' are bisimulations. Then $\langle s, !(s) \rangle \in R$ and $\langle s', !(s') \rangle \in R'$. Hence $\langle !(s), !(s') \rangle$ belongs to the bisimulation $R' \circ V \circ R^{-1}$ by Theorem 2.16 and so $!(s)$ and $!(s')$ are bisimilar. Theorem 2.19 shows that $!(s) = !(s')$, as desired. \square

3 Final automata

In [21], the following description of a final deterministic automaton is presented, which is based on an algorithm of Brzozowski [8]. Let $\mathcal{L} = \mathcal{P}A^*$ be the set of all languages over A . Given a word $w \in A^*$, the w -derivative or left w -quotient of a language L is $w^{-1}L = \{v \in A^* \mid wv \in L\}$. A particular case is the a -derivative $a^{-1}L = \{v \in A^* \mid av \in L\}$ for $a \in A$, which can be used to give \mathcal{L} a structure of automaton in the following way: $\delta(L, a) = a^{-1}L$ and the language L is final if and only if the empty word ϵ belongs to L . The language accepted by a state L is precisely L itself. This automaton, called the *language automaton*, is final and the unique homomorphism from a given automaton S into \mathcal{L} is $!(s) = L_s$, the language accepted by the automaton S when it starts from the state s . In particular, two states are bisimilar if and only if the languages accepted by the automaton from these states coincide.

For partial deterministic automata, Silva, Bonchi *et al.* mention in [26] that the images in the final object for this category of the states of a partial deterministic automaton are pairs of prefix-closed languages $\langle V, W \rangle$, where V

contains all words labelling the paths leading to final states and W contains the words labelling the paths leading to possible states, either final or non-final.

Consider now non-deterministic automata. It is easy to see that bisimilar states accept the same language: Suppose that s and s' are bisimilar states of the automata (S, A, δ, S_f) and (S', A, δ', S'_f) , respectively, and $w = a_1 a_2 \cdots a_n \in L_s$, the language associated to s in the first automaton. Then there exists a sequence of states

$$\langle s_0, s_1, s_2, \dots, s_n \rangle$$

such that $s_0 = s$, $s_i \in \delta(s_{i-1}, a_i)$ for $1 \leq i \leq n$, and $s_n \in S_f$. By bisimilarity, there exists a sequence of states $s'_0, s'_1, s'_2, \dots, s'_n$ such that $s'_0 = s'$ and $s'_i \in \delta'(s'_{i-1}, a_i)$ such that s_i is bisimilar to s'_i for $1 \leq i \leq n$. By Example 2.14, then either s_i and s'_i are both final or none of them is final. Since $s_n \in S_f$, it follows that $s'_n \in S'_f$ and so $w \in L'_{s'}$, the language associated to s in the second automaton. Therefore $L_s \subseteq L'_{s'}$. A similar argument shows that $L'_{s'} \subseteq L_s$ and so $L_s = L'_{s'}$. However, this is not sufficient to identify bisimilar states, as the following example shows.

Example 3.1. Consider the automaton given by $S = \{1, 2, 3, 4\}$, $A = \{a\}$, $\delta(1) = \{1, 2, 3, 4\}$, $\delta(2) = \{1, 2, 3\}$, $\delta(3) = \{3, 4\}$, $\delta(4) = \emptyset$, and $S_f = \{4\}$. This automaton is represented in Figure 1.

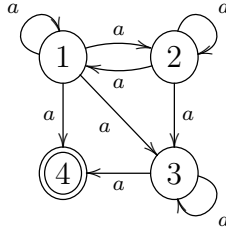

Figure 1: Automaton of Example 3.1

We can see that $L_1 = L_3 = aa^*$, $L_2 = a^2a^*$, and $L_4 = \epsilon$ (we identify the regular languages with their corresponding regular expressions). However, 1 and 3 are not bisimilar. To see this, we note that from 1 we can make a transition to 2, with language a^2a^* , but from 3 we can only make transitions to 3 and 4, with respective languages aa^* and ϵ . However, by the previous remark, 2 cannot be bisimilar to neither 3 nor 4.

In the following paragraphs, we shall present some descriptions of final coalgebras for some functors in the category **Set**. Bonsangue, Rutten, and

Silva (see [7, 25, 27]) have considered categories of coalgebras for Kripke polynomial functors in the category **Set** of sets and functions, which include automata, and have described the subcoalgebra of the final coalgebra containing the images of the corresponding finite coalgebras. In their description, they construct a set of expressions based on the elementary components of the functor and an equivalence relation between these expressions. The quotient set of these expressions modulo this equivalence relation admits a structure of a coalgebra for this functor which turns out to be the subcoalgebra of the final coalgebra containing the images of the finite coalgebras.

The finite power-set functor \mathcal{P}_ω and other related functors on the category **Set** have deserved special attention. A non-ordered finitely branching tree is said to be *extensional* if subtrees rooted at distinct children are not isomorphic. From one tree, it is possible to obtain an extensional quotient by identifying two identical subtrees of nodes of the tree and repeating it for a possibly transfinite number of steps. We say that two trees are *extensionally equivalent* when they reduce to the same extensional tree, and are *similar* when the trees of depth n obtained by truncation are extensionally equivalent for all n . Barr [5] described the final \mathcal{P}_ω -coalgebra as the quotient coalgebra of the coalgebra composed of all extensional finitely branching trees modulo this relation of similarity. Another relevant description of the final coalgebra for the power-set functor was given by Worrell in [29] (see also Adámek *et al.* [4]). Let us call a tree t *strongly extensional* if for every n there exists $m \geq n$ such that the truncation of depth n of t coincides with the truncation of depth n of the result of taking the truncation of depth m of t and collapsing it with respect to extensional equivalence. The set T of all finitely branching, strongly extensional trees has a coalgebra structure $\alpha: T \rightarrow \mathcal{P}_\omega(T)$ assigning to every tree the set of all maximal proper subtrees. This \mathcal{P}_ω -coalgebra is final.

Kozen [18] has presented a combinatorial description of final coalgebras on **Set**. In his work, the role of the functor is played by what he calls a *type signature*, which is a directed multigraph whose nodes are designated as *universal* or *existential*. Universal nodes, denoted by rectangles, correspond to product constructors, while existential nodes, denoted by diamonds, correspond to coproduct constructors. If F is a type signature, an *F-realisation* is a directed multigraph G together with a multigraph homomorphism $l: G \rightarrow F$, called a *typing*, satisfying the following properties:

- If $l(u)$ is existential, then there is exactly one edge of G with source u .
- If $l(u)$ is universal, then l is a bijection between the edges of G with source u and the edges of F with source $l(u)$.

A homomorphism of F -realisations is a multigraph homomorphism that commutes with the types.

Let F be a type signature with nodes V_F . An F -coalgebra is a V_F -indexed collection of pairs (A_s, α_s) , where the A_s are sets and the α_s are set functions

$$\alpha_s: A_s \longrightarrow \begin{cases} \sum_{\text{src } e=s} A_{\text{tgt } e}, & \text{if } s \text{ is existential,} \\ \prod_{\text{src } e=s} A_{\text{tgt } e}, & \text{if } s \text{ is universal,} \end{cases}$$

where $\text{src } e$ and $\text{tgt } e$ denote, respectively, the source and the target of the arc e .

A morphism of F -coalgebras is a V_F -indexed collection of set maps h_s that commute with the α_s in the usual way. This corresponds to the traditional definition of a coalgebra for an endofunctor on \mathbf{Set}^V . If the type signature is *accessible*, that is every node is accessible from a fixed node, then it is possible to find an endofunctor \mathcal{F} on \mathbf{Set} such that the categories of F -coalgebras and \mathcal{F} -coalgebras are naturally isomorphic.

Kozen showed the existence of a pair of functors between the category of F -coalgebras and the category of F -realisations, one in each direction, that are inverses up to natural isomorphisms. He proves that these two categories are equivalent and, as a consequence, we can obtain a description of the final F -coalgebra from the final F -realisation.

The final object for the category of F -realisations is showed to be the realisation (R_F, l_F) defined as follows. A node of R_F is a set A of finite paths in F such that:

1. A is non-empty and prefix-closed;
2. all paths in A have the same first node, called $l_F(A)$;
3. if p is a path in A of length n and its tail node is existential, then there exists exactly one path of length $n + 1$ in A extending p ;
4. if p is a path in A of length n and its tail node is universal, then all paths of length $n + 1$ extending p are in A .

The arcs of R_F are defined as follows. Let A be a set of paths in F and e an arc of F . The *Brzozowski derivative* of A with respect to e is the set $D_e(A)$ of paths obtained by removing the initial edge e from all paths in A starting with that edge. If A is a node of R_f and $D_e(A)$ is non-empty, we add exactly one edge $\langle A, e \rangle$ from A to $D_e(A)$ in R_F and we make $l_F(\langle A, e \rangle) = e$. As shown in [18, Theorem 3.2], this realisation is a final object in the category of F -realisations.

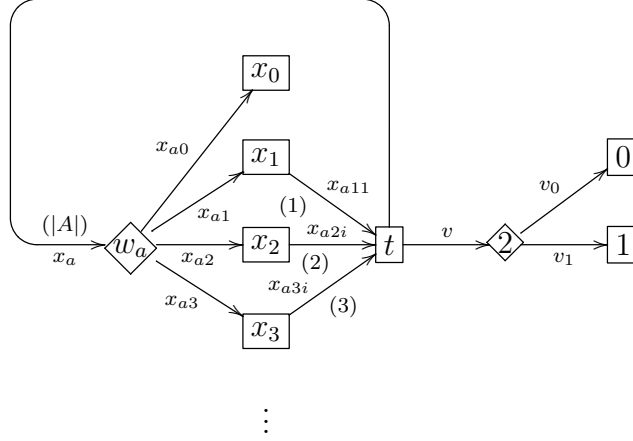

Figure 2: Graph of the type signature for non-deterministic automata

We have not found in [18] the description of a type signature corresponding to non-deterministic automata. Nevertheless, from the examples in this paper we see that a possible signature type for non-deterministic automata is the graph drawn on Figure 2, where the nodes with label t , 0 , 1 , and x_i , $i \in \mathbb{N} \cup \{0\}$, are universal and the node labelled as 2 and the nodes w_a , $a \in A$, are existential; for every $a \in A$ there exists an arc x_a from t to w_a and an arc v from t to 2 ; there is an arc v_0 from 2 to 0 and an arc v_1 from 2 to 1 ; from w_a to x_i , $i \in \mathbb{N} \cup \{0\}$, there is an arc x_{ai} , and from x_i to t , $i \in \mathbb{N}$, there are i arcs labelled as x_{aij} , $1 \leq j \leq i$.

In the following we will describe an automaton \mathcal{A} as an F -realisation (G, l) . We introduce a procedure to construct a multigraph starting from the graph of the automaton. To every state s in the graph, depending on its nature, we will add the following multigraphs:

- If s is not a final state, we add:



- If s is a final state, we add:



- For every input letter a ,

if s has n a -labelled outgoing arcs, we replace them by:

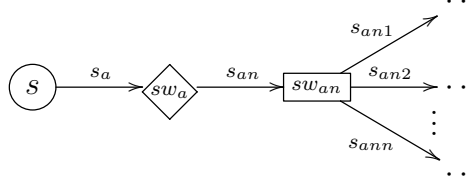

if s has no a -labelled outgoing arcs, we add:

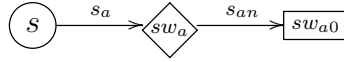

This procedure will give us a multigraph. To complete the description of the realisation we specify its typing l on the final realisation as follows:

$$\begin{array}{ccc} \diamond_{sw_a} \mapsto \diamond_{w_a}, & \diamond_{s2} \mapsto \diamond_2, & \circ_s \mapsto \square_t, \\ \square_{sw_{an}} \mapsto \square_{x_n}, & \square_1 \mapsto \square_1, & \square_0 \mapsto \square_0. \end{array}$$

Example 3.2. Let us exemplify the last procedure on the small automaton $\mathcal{A} = (S, A, S_f, \delta)$ with set of states $S = \{1, 2, 3\}$, alphabet $A = \{a\}$, set of final states $S_f = \{3\}$, and transitions given by $\delta(1, a) = \{2, 3\}$, $\delta(2, a) = \{2, 3\}$, $\delta(3, a) = \emptyset$. This automaton and the result of this procedure are represented in Figure 3.

The previous description of the final F -realisation applied to this signature type is the first description we know for the final object for the category of non-deterministic automata that is not given in terms of equivalence classes of a bisimilarity relation, in the sense that in the final automaton, bisimilarity is just a set equality. Kozen also shows at the end of the paper [18] how to characterise the elements of the final realisation as labelled trees.

A slight modification of this type signature, drawn on Figure 4, gives the type signature corresponding to the \mathcal{P}_ω -coalgebras, where \mathcal{P}_ω is the finite power-set functor. Its final realisation can be obtained from the strongly extensional trees of Worrell [29] by replacing the edges of the form $s \longrightarrow s'$ by a path $t \longrightarrow x_i \longrightarrow t$, where i is the number of children of s , and a leaf s is replaced by a path $t \longrightarrow x_0$. Hence the strongly extensional trees are recovered with this description.

Some recent descriptions of minimisations of non-deterministic automata have been presented by Brzozowski and Tamm [9] and Adámek, Bonchi *et al.* [3]. We mention them here because they are based on the languages associated to every state of the automaton. However, their way of minimising

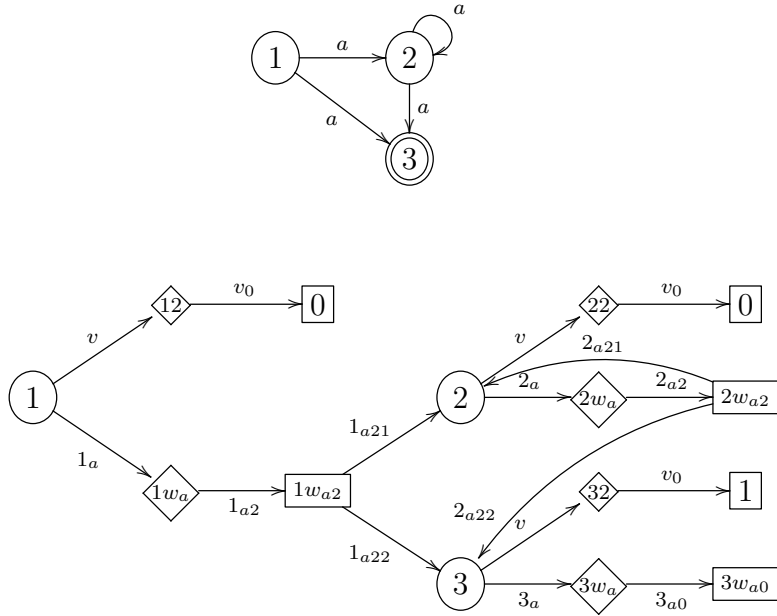

Figure 3: The realisation of an automaton from its graph

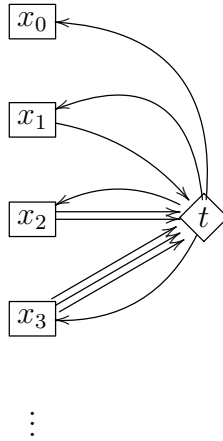

Figure 4: Graph of the type signature for the finite power-set functor

automata differs from ours, since they only pay attention to the languages associated to every state instead of bisimilarity, as we do. We present them here in order to show the differences with our approach. The problem considered there is the following. Given a regular language L over an alphabet A , minimal deterministic automata can be considered as *canonical* acceptors of the given language L . The question is whether it is possible to find an analogous canonical non-deterministic automaton. In [9], the quotients L_1, L_2, \dots, L_n of the form $w^{-1}L$ of a given regular language L are considered. The non-empty intersections of languages of the form $\widehat{L}_1 \cap \dots \cap \widehat{L}_n$ such that \widehat{L}_i is equal to L_i or to its complement \overline{L}_i in which at least one of the L_i is not complemented are called the *atoms* of L . The non-deterministic automaton having the atoms of L as languages as states is called the *átomaton* of L . For a non-deterministic finite automaton, its *determinisation* is the deterministic finite automaton obtained by the well-known subset construction, where only subsets (including the empty subset) reachable from the initial state of \mathcal{A} are used. In [9], the authors show that the determinisation of the átomaton of a regular language L coincides with the minimal deterministic automaton associated to this language.

In [3], a coalgebraic point of view of this kind of description is presented. However, non-deterministic automata are considered there as coalgebras for the functor $A \times \text{Id} + 1: \mathbf{Rel} \rightarrow \mathbf{Rel}$, where \mathbf{Rel} denotes the category of sets and relations. The final object in this category is A^* , and the unique morphism is the relation which assigns to each state all the words sending this state to an accepting state. Under this interpretation, bisimilarity is just language equality. This point of view is different from the one used in this paper. Equivalent descriptions of this automaton can be found in both papers and in the references inside them.

For the case of automata, regarded as labelled transition systems, the previous descriptions do not give, in our opinion, a clear idea of the role of languages in the final automaton. It seems desirable to find, like in the case of deterministic automata, a description which emphasises the role of languages as natural objects to describe the behaviour of automata. This is the aim of the present paper. Our description needs the following concepts.

Definition 3.3. A *language sequence* over an alphabet A is a finite sequence of the form

$$\langle L_0, a_1, L_1, a_2, L_2, \dots, L_{r-1}, a_r, L_r \rangle$$

where L_i are languages, that is, elements of $\mathcal{P}(A^*)$ for $0 \leq i \leq r$, $a_i \in A$ for $1 \leq i \leq r$, and $a_i L_i \subseteq L_{i-1}$ for $1 \leq i \leq r$. The number r is called the *length* of the language sequence. A sequence formed by a unique language L_0 will be called a language sequence of length zero.

Definition 3.4. A language sequence $\langle L_0, a_1, L_1, \dots, L_{r-1}, a_r, L_r \rangle$ over A is said to be a *prefix* of the language sequence $\langle M_0, b_1, M_1, \dots, M_{s-1}, b_s, M_s \rangle$ over the same alphabet A when $r \leq s$ and $L_j = M_j$ for $0 \leq j \leq r$ and $a_j = b_j$ for $1 \leq j \leq r$.

Definition 3.5. A *language tree* is a (possibly empty) set of language sequences T satisfying the following conditions:

1. Every prefix of a language sequence in T belongs to T .
2. Given a language sequence

$$s = \langle L_0, a_1, L_1, \dots, L_{k-1}, a_k, L_k \rangle \in T,$$

the set

$$N_s = \{z \in T \mid z \text{ is of length } k+1 \text{ and } s \text{ is a prefix of } z\}$$

is finite and

$$L_k \setminus \{\epsilon\} = \bigcup \{a_{k+1}L_{k+1} \mid \langle L_0, a_1, L_1, \dots, L_k, a_{k+1}, L_{k+1} \rangle \in N_s\}. \quad (1)$$

When $N_s = \emptyset$, this union is understood to be \emptyset , and so $L_k = \{\epsilon\}$ or $L_k = \emptyset$.

3. If T is not empty, then there is a unique language sequence $\langle L_0 \rangle$ in T of length zero. The language L_0 is called the *initial language* of the language tree.

Definition 3.6. A *chain of language trees* over an alphabet A is a finite sequence

$$\langle T_0, a_0, T_1, a_1, T_2, \dots, T_{r-1}, a_r, T_r \rangle$$

in which T_i is a non-empty language tree over A for $0 \leq i \leq r$, $a_i \in A$ for $1 \leq i \leq r$ such that $\{\langle L_0, a_0, L_1, \dots, L_t \rangle \mid \langle L_1, \dots, L_t \rangle \in T_1\} \subseteq T_0$. The *initial language* of a chain of language trees $\langle T_0, a_0, T_1, \dots, T_r \rangle$ is the initial language of the first language tree T_0 . The number r is called the *length* of the chain of language trees. The sequence T_0 of a single non-empty language tree over A will be considered a chain of language trees of length zero.

Definition 3.7. A chain of language trees $\langle T_0, a_1, T_1, \dots, T_{r-1}, a_r, T_r \rangle$ over A is said to be a *prefix* of the chain of language trees $\langle U_0, b_1, U_1, \dots, U_{s-1}, b_s, U_s \rangle$ over the same alphabet A when $r \leq s$ and $T_j = U_j$ for $0 \leq j \leq r$ and $a_j = b_j$ for $1 \leq j \leq r$.

Now we are in a position to define the states of the final automaton.

Definition 3.8. A *tree of chains of language trees* over an alphabet A is a set of chains of language trees \mathcal{T} satisfying:

1. Every prefix of a chain of language trees in \mathcal{T} is also in \mathcal{T} .
2. Given a chain of language trees

$$U = \langle T_0, a_1, T_1, \dots, T_{k-1}, a_k, T_k \rangle \in \mathcal{T},$$

the set

$$N_U = \{V \in \mathcal{T} \mid V \text{ is of length } k+1 \text{ and } U \text{ is a prefix of } V\}$$

is finite and

$$T_k = \bigcup \{c(L_k, a_{k+1}, T_{k+1}) \mid \langle T_0, a_1, T_1, \dots, T_k, a_{k+1}, T_{k+1} \rangle \in N_U\}$$

where L_k is the initial language of T_k and

$$c(L_k, a_{k+1}, T_{k+1}) = \{\langle L_k, a_{k+1}, M_0, b_0, M_1, \dots, M_r \rangle \mid \langle M_0, b_0, M_1, \dots, M_r \rangle \in T_{k+1}\}.$$

3. There is a unique chain of language trees in \mathcal{T} of length zero. Its initial language is called the *initial language* of \mathcal{T} and denoted by $\text{Init}(\mathcal{T})$.

Definition 3.9. The *language tree automaton* over the alphabet A is

$$\mathcal{L} = (S_{\mathcal{L}}, A, S_{\mathcal{L},f}, \delta_{\mathcal{L}})$$

such that:

1. $S_{\mathcal{L}}$ is the set of all possible trees of chains of language trees over A ,
2. a tree of chains of language trees \mathcal{T} belongs to the set $S_{\mathcal{L},f}$ of final states if and only if the empty word ϵ belongs to $\text{Init}(\mathcal{T})$, and
3. given a tree of chains of language trees \mathcal{T} and $a_1 \in A$, $\delta_{\mathcal{L}}(\mathcal{T}, a_1)$ consists of all trees \mathcal{U} of chains of language trees of the form

$$\mathcal{U} = \{\langle T_1, a_2, T_2, \dots, T_{k-1}, a_k, T_k \rangle \mid \langle T_0, a_1, T_1, a_2, T_2, \dots, T_{k-1}, a_k, T_k \rangle \in \mathcal{T}\},$$

where all chains of language trees of \mathcal{T} begin with the language tree T_0 .

Our next goal is to show that the language tree automaton over the alphabet A is a final object for the category of automata over the alphabet A . This will require checking that given an automaton \mathcal{A} , there exists a unique homomorphism between \mathcal{A} and \mathcal{L} . We begin by introducing this homomorphism.

Definition 3.10. Let $\mathcal{A} = (S, A, S_f, \delta)$ be an automaton. Let $q_0 \in S$. A sequence

$$\langle q_0, a_1, q_1, a_2, q_2, \dots, q_{r-1}, a_r, q_r \rangle$$

with $q_i \in S$, $0 \leq i \leq r$, $a_i \in A$, $1 \leq i \leq r$, and $q_i \in \delta(q_{i-1}, a_i)$ for $1 \leq i \leq r$ will be called a *state sequence* in \mathcal{A} .

Description 3.11. Let $\mathcal{A} = (S, A, S_f, \delta)$ be an automaton. For each state $s \in S$, let L_s denote the language accepted by \mathcal{A} when it starts from s . For each state sequence

$$\langle q_0, a_1, q_1, a_2, q_2, \dots, q_{r-1}, a_r, q_r \rangle,$$

consider the language sequence $\langle L_{q_0}, a_1, L_{q_1}, a_2, L_{q_2}, \dots, L_{q_{r-1}}, a_r, L_{q_r} \rangle$. Let T_{q_0} be the set of all possible sequences which can be obtained in this way from all sequences of states starting with q_0 . Note that T_{q_0} is a language tree because $L_q \setminus \{\epsilon\} = \bigcup \{aL_{q'} \mid q' \in \delta(q, a), a \in A\}$ in an automaton for every state q . Now for each state sequence $\langle q_0, a_1, q_1, a_2, q_2, \dots, q_{r-1}, a_r, q_r \rangle$ we consider

$$\langle T_{q_0}, a_1, T_{q_1}, a_2, T_{q_2}, \dots, T_{q_{r-1}}, a_r, T_{q_r} \rangle,$$

which is a chain of language trees. Then the set \mathcal{Q}_{q_0} of all chains of language trees which can be obtained from all possible state sequences starting with q_0 is a tree of chains of language trees.

Theorem 3.12. *Let $\mathcal{A} = (S, A, S_f, \delta)$ be an automaton. The function $\phi: S \rightarrow S_{\mathcal{L}}$ which assigns to each state $s \in S$ the tree of chains of language trees \mathcal{Q}_s of Description 3.11 induces a homomorphism of automata between \mathcal{A} and \mathcal{L} .*

Proof. It is clear that if $s' \in \delta(s, a)$, then $\mathcal{Q}_{s'} \in \delta_{\mathcal{L}}(\mathcal{Q}_s, a)$. Conversely, suppose that $\mathcal{U} \in \delta_{\mathcal{L}}(\mathcal{Q}_s, a)$. Then \mathcal{U} is a tree of chains of language trees that has been obtained by removing the first element and a in all language sequences in the chains of language trees in \mathcal{Q}_s which begin with $\langle T_{q_0}, a \rangle$. But then we get that \mathcal{U} is one of the trees of chains of language trees $\mathcal{Q}_{s'}$ with $s' \in \delta(s, a)$. Therefore the function ϕ respects the transitions. Now assume that $q_0 \in S_f$. Then $\epsilon \in L_{q_0}$. Moreover $\text{Init}(\mathcal{Q}_{q_0}) = L_{q_0}$ and since ϵ is one of the elements of this language, $\mathcal{Q}_{q_0} \in S_{\mathcal{L}, f}$. On the other hand, if \mathcal{Q}_s is a final state, then $\epsilon \in \text{Init}(\mathcal{Q}_s)$. Hence ϵ is in the language accepted by \mathcal{A} when it starts from s and so $s \in S_f$. \square

Theorem 3.13. *Let ψ be a homomorphism between an automaton $\mathcal{A} = (S, A, S_f, \delta)$ and \mathcal{L} . Then ψ coincides with the homomorphism ϕ of Theorem 3.12. As a consequence, \mathcal{L} is a final object in the category of automata over the alphabet A .*

Proof. The proof will consist of checking that for every state $q_0 \in S$, $L_{q_0} = \text{Init}(\mathcal{Q}_0)$, where L_{q_0} is the language accepted by \mathcal{A} starting from q_0 and $\mathcal{Q}_0 = \psi(q_0)$. This will be used later to prove that ψ and ϕ coincide. For the reader's convenience, we break the proof into separately stated steps.

1. Let $q_0 \in S$. Then $L_{q_0} \subseteq \text{Init}(\mathcal{Q}_0)$.

Let w be a word in L_{q_0} . If $w = \epsilon$, then q_0 is a final state and so $\psi(q_0)$ is also a final state; in particular, $\epsilon \in \text{Init}(\mathcal{Q}_0)$ where $\mathcal{Q}_0 = \psi(q_0)$. Suppose that $w = a_1 a_2 \dots a_r$. Then there exists a state sequence

$$\langle q_0, a_1, q_1, a_2, q_2, \dots, q_{r-1}, a_r, q_r \rangle$$

such that $q_r \in S_f$. Then $\langle \mathcal{Q}_0, a_1, \mathcal{Q}_1, a_2, \mathcal{Q}_2, \dots, \mathcal{Q}_{r-1}, a_r, \mathcal{Q}_r \rangle$, where $\mathcal{Q}_i = \psi(q_i)$, $0 \leq i \leq r$, is a state sequence in \mathcal{L} and $\mathcal{Q}_r \in S_{\mathcal{L},f}$ is final. Hence $\epsilon \in \text{Init}(\mathcal{Q}_r)$ and so $a_r \in \text{Init}(\mathcal{Q}_{r-1})$, $a_{r-1} a_r \in \text{Init}(\mathcal{Q}_{r-2})$, and, by induction, we see that $w = a_1 a_2 \dots a_r \in \text{Init}(\mathcal{Q}_0)$. Therefore $L_{q_0} \subseteq \text{Init}(\mathcal{Q}_0)$.

2. Conversely, $\text{Init}(\mathcal{Q}_0) \subseteq L_{q_0}$.

Consider $w \in \text{Init}(\mathcal{Q}_0)$. If $w = \epsilon$, then $\mathcal{Q}_0 \in S_{\mathcal{L},f}$ is final and so $q_0 \in S_f$ is final. Therefore $\epsilon \in L_{q_0}$. Suppose now that $w = a_1 a_2 \dots a_r$. Note that \mathcal{Q}_0 is a tree of language trees and so \mathcal{Q}_0 is composed of chains of language trees $\langle T_0, b_1, T_1, \dots, T_{s-1}, b_s, T_s \rangle$ satisfying the conditions of Definition 3.8. Now each T_i is a language tree and so it is composed by language sequences $\langle L_0, c_1, L_1, \dots, L_{t-1}, c_t, L_t \rangle$ satisfying the conditions of Definition 3.6. Let T_0 be the unique prefix of length zero of all chains of language trees of \mathcal{Q}_0 and let L_0 be the unique prefix of length zero of T_0 . By the condition of Equation (1) in Definition 3.5, there exists a language L_1 such that $a_2 \dots a_r \in L_1$, and the language sequence $\langle L_0, a_1, L_1 \rangle$ is in T_0 , there exists a language L_2 such that $a_3 \dots a_r \in L_2$ and $\langle L_0, a_1, L_1, a_2, L_2 \rangle \in T_0$, and, by induction, we see that there exists a language L_r such that the empty word ϵ is in L_r and $\langle L_0, a_1, L_1, a_2, L_2, \dots, L_{r-1}, a_r, L_r \rangle \in T_0$. By Definition 3.8 (2), we obtain that there exists a language tree T_1 such that the language sequence $\langle L_1, a_2, L_2, \dots, L_{r-1}, a_r, L_r \rangle$ is in T_1 and $\langle T_0, a_1, T_1 \rangle$ is a chain of language trees in \mathcal{Q}_0 , and, once again by induction, we

find that there exists a language tree T_r such that the language sequence $\langle L_r \rangle$ belongs to T_r and $\langle T_0, a_1, T_1, a_2, T_2, \dots, T_{r-1}, a_r, T_r \rangle$ is a chain of language trees in \mathcal{Q}_0 . By Definition 3.9 (3), there exists a tree of chains of language trees \mathcal{Q}_1 such that $\langle T_1, a_2, T_2, \dots, T_{r-1}, a_r, T_r \rangle$ is a tree of chain of language trees in \mathcal{Q}_1 and $\langle \mathcal{Q}_0, a_1, \mathcal{Q}_1 \rangle$ is a state sequence in \mathcal{L} , and so on, with another inductive argument, we find the existence of a tree of chains of language trees \mathcal{Q}_r such that $\langle T_r \rangle \in \mathcal{Q}_r$ and $\langle \mathcal{Q}_0, a_1, \mathcal{Q}_1, \dots, \mathcal{Q}_{r-1}, a_r, \mathcal{Q}_r \rangle$ is a state sequence in \mathcal{L} . The state \mathcal{Q}_r is final, because $\epsilon \in L_r = \text{Init}(\mathcal{Q}_r)$. Since ψ is a homomorphism of automata, there exists a state sequence $\langle q_0, a_1, q_1, \dots, q_{r-1}, a_r, q_r \rangle$ in \mathcal{A} such that $\psi(q_i) = \mathcal{Q}_i$ for $1 \leq i \leq r$ and q_r is final, because \mathcal{Q}_r is final. It follows that $w \in L_{q_0}$. This shows that $\text{Init}(\mathcal{Q}_0) \leq L_{q_0}$ for all $q_0 \in S$.

3. The homomorphism ψ coincides with ϕ .

Now let $\langle q_0, a_1, q_1, \dots, q_{r-1}, a_r, q_r \rangle$ be a state sequence in \mathcal{A} . Since ψ is a homomorphism of automata, $\langle \psi(q_0), a_1, \psi(q_1), \dots, \psi(q_{r-1}), a_r, \psi(q_r) \rangle$ is a state sequence in \mathcal{L} . By using an argument similar to the one used in the previous paragraph and the fact that the initial language of $\psi(q)$ is L_q , we see that the tree of language sequences T_0 of the prefix of length zero of $\mathcal{Q}_0 = \psi(q_0)$ contains the language sequence $\langle L_{q_0}, a_1, L_{q_1}, \dots, L_{q_{r-1}}, a_r, L_{q_r} \rangle$. Now let $\langle L_0, a_1, L_1, \dots, L_{r-1}, a_r, L_r \rangle$ be a language sequence in the tree of language sequences T_0 of the prefix of length zero of $\psi(q_0)$. The ideas of the previous paragraph show that there is a chain of trees of language trees $\langle T_0, a_1, T_1, \dots, T_{r-1}, a_r, T_r \rangle$ in which the initial language of T_i is L_i for $0 \leq i \leq r$, and that there exists a state sequence in \mathcal{L} of the form $\langle \mathcal{Q}_0, a_1, \mathcal{Q}_1, \dots, \mathcal{Q}_{r-1}, a_r, \mathcal{Q}_r \rangle$ with $\text{Init}(\mathcal{Q}_i) = L_i$ for $0 \leq i \leq r$. The fact that ψ is a homomorphism implies that there exists a state sequence

$$\langle q_0, a_1, q_1, \dots, q_{r-1}, a_r, q_r \rangle$$

in \mathcal{A} with $\mathcal{Q}_i = \psi(q_i)$ and so the language sequence

$$\langle L_0, a_1, L_1, \dots, L_{r-1}, a_r, L_r \rangle$$

coincides with

$$\langle L_{q_0}, a_1, L_{q_1}, \dots, L_{q_{r-1}}, a_r, L_{q_r} \rangle.$$

It follows that $\psi = \phi$. □

Theorems 2.20 and 3.13 yield the following result:

Corollary 3.14. *Given two automata (S, A, S_f, δ) and (S', A, S'_f, δ) over the same alphabet A , two states $s \in S$ and $s' \in S'$ are bisimilar if and only if the trees of chains of language trees obtained from s and s' according to Description 3.11 coincide.*

Example 3.15. Consider the automaton of Example 3.1. We can represent the corresponding trees of language sequences in Figure 5. Intuitively, what we do to obtain the images in \mathcal{L} of each state is to substitute each element of the tree by the complete tree which can be formed from this element. We show it in Figure 6. The fact that the states 1 and 3 are not bisimilar is shown by the fact that \mathcal{Q}_1 and \mathcal{Q}_3 are different (in fact, T_1 and T_3 are different).

We note that the set of all language sequences obtained from the state 3

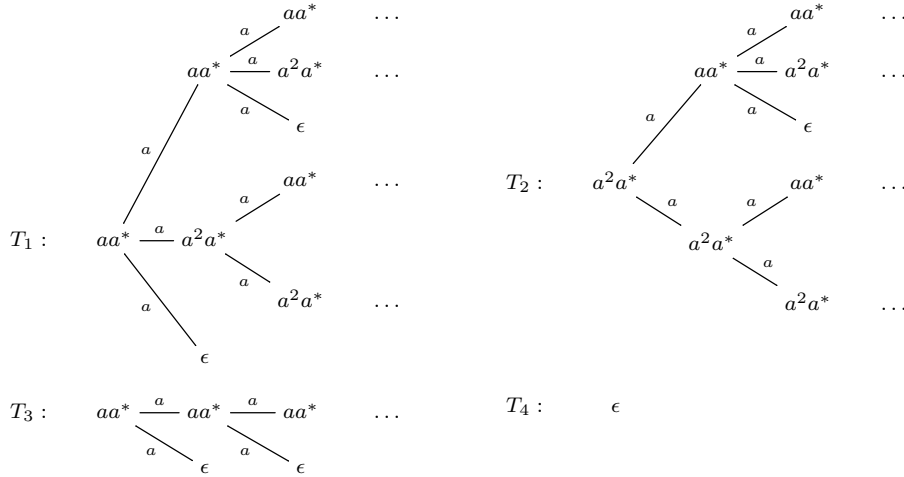

Figure 5: Language trees of the automaton of Example 3.15

is a subset of the set of all language sequences obtained from the state 1. This is the reason we see in T_1 only three children aa^* , a^2a^* and ϵ and in T_2 only two children aa^* and a^2a^* . However, we cannot determine from the chain of languages $\langle aa^*, a, aa^*, a, aa^*, \dots, aa^*, a, aa^* \rangle$ whether it corresponds to the state sequence $\langle 1, a, 1, a, 1, \dots, 1, a, 1 \rangle$, to $\langle 1, a, 1, a, 1, \dots, 1, a, 3 \rangle, \dots$, or to $\langle 3, a, 3, a, 3, \dots, 3, a, 3 \rangle$. This distinction appears in the children of the roots of \mathcal{Q}_1 and \mathcal{Q}_2 .

Example 3.16. One might think the final automaton could be described in an easier way by means of the trees of language sequences. In order to show that this is false, we can consider the automaton $\mathcal{A} = (S, A, S_f, \delta)$,

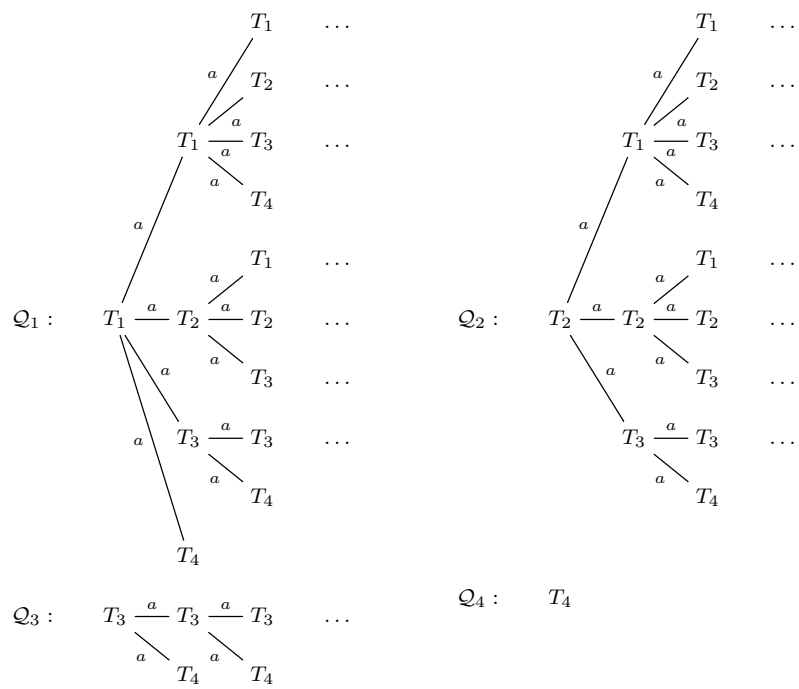

Figure 6: Images of the states in the final automaton \mathcal{L} of the automaton of Example 3.15

with $S = \{1, 2, \dots, 11\}$, $A = \{a, b\}$, $S_f = \{4, 6\}$, $\delta(1, a) = \{8\}$, $\delta(1, b) = \{2, 8\}$, $\delta(2, a) = \{3, 5\}$, $\delta(2, b) = \{5\}$, $\delta(3, a) = \{2\}$, $\delta(3, b) = \{4\}$, $\delta(4, a) = \{4\}$, $\delta(4, b) = \emptyset$, $\delta(5, a) = \{2\}$, $\delta(5, b) = \{4, 6\}$, $\delta(6, a) = \{6\}$, $\delta(6, b) = \emptyset$, $\delta(7, a) = \delta(7, b) = \{8\}$, $\delta(8, a) = \{4, 8\}$, $\delta(8, b) = \{6, 8, 9\}$, $\delta(9, a) = \{10, 11\}$, $\delta(9, b) = \emptyset$, $\delta(10, a) = \{10\}$, $\delta(10, b) = \delta(11, a) = \delta(11, b) = \emptyset$. A graphical representation of this automaton appears in Figure 7.

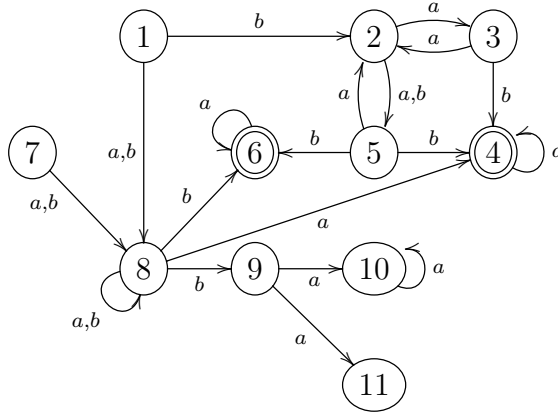
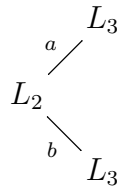

Figure 7: Automaton of Example 3.16

We can use the **Automata** package [10] of the computer algebra system GAP [11] to check that the languages associated with each of the states are

$$\begin{aligned}
 L_1 &= L_7 = (a + b)^2(a + b)^*, \\
 L_2 &= ((a + b)a)^*(a + b)ba^*, \\
 L_3 &= L_5 = (a(a + b))^*ba^*, \\
 L_4 &= L_6 = a^*, \\
 L_8 &= (a + b)(a + b)^*, \\
 L_9 &= L_{10} = L_{11} = \emptyset.
 \end{aligned}$$

The trees of language sequences corresponding to each state are represented in Figure 8 and Figure 9. A branch labelled with more than one letter like $L_2 \xrightarrow{a,b} L_3$ is abbreviation of the multiple branch



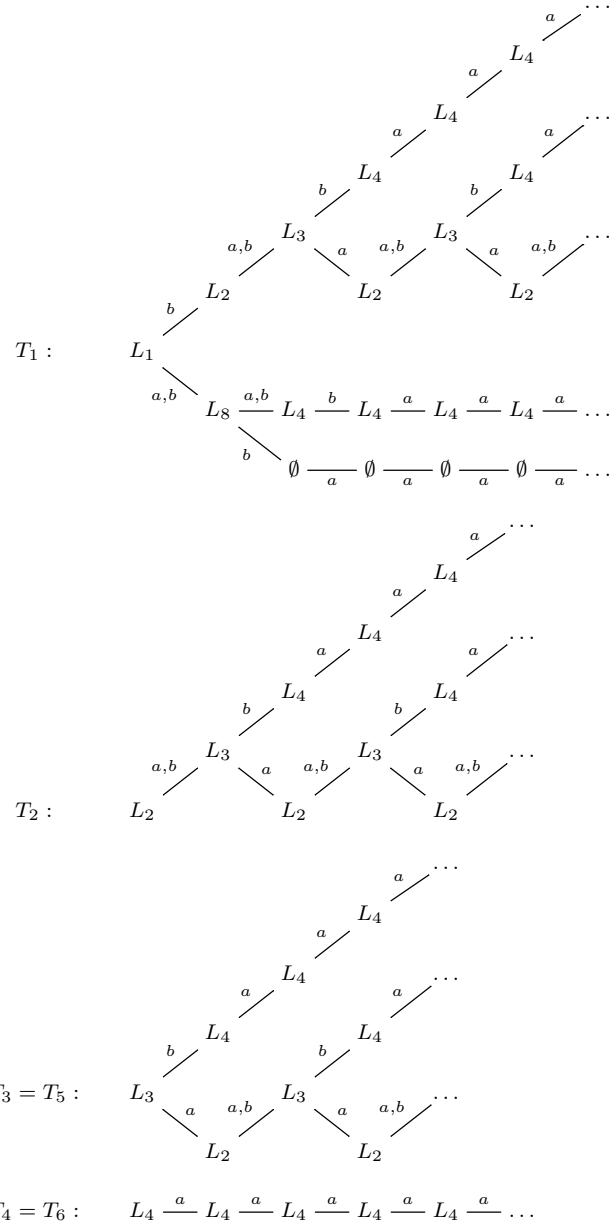

Figure 8: Language sequences of Example 3.16

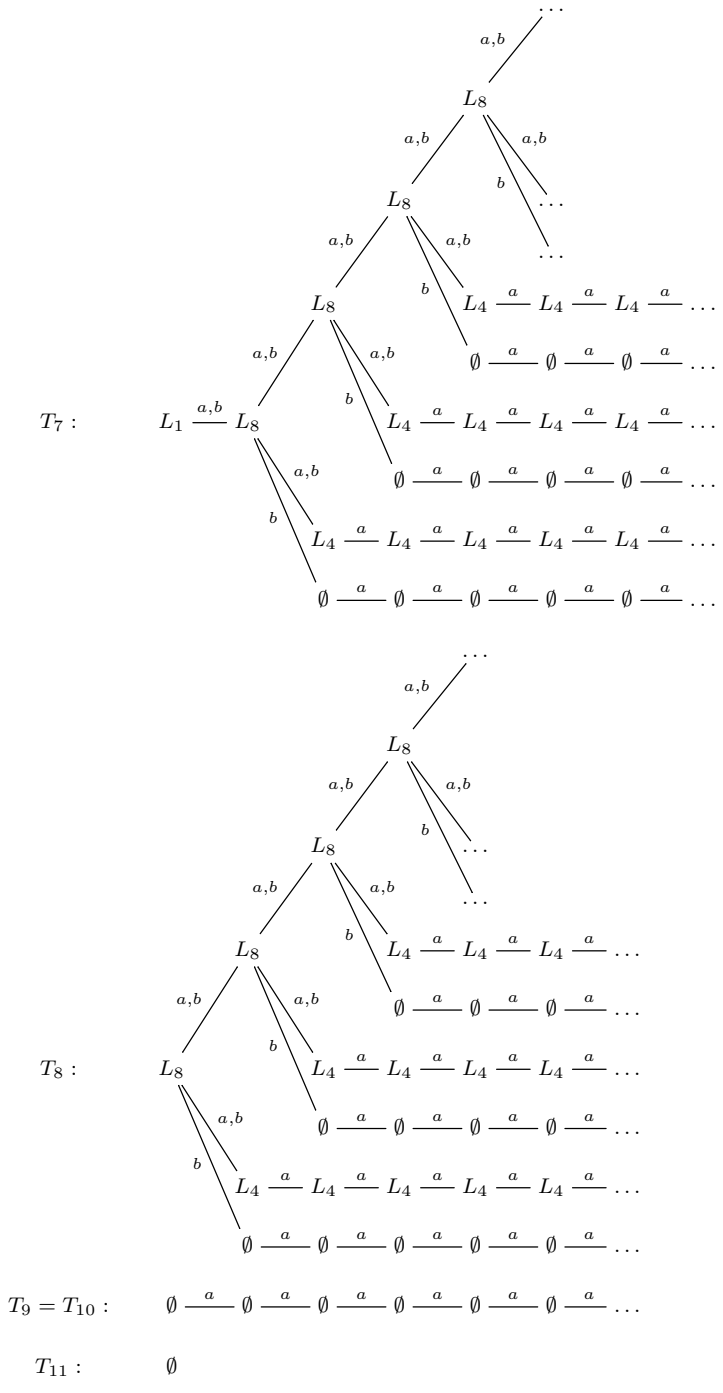

Figure 9: Language sequences of Example 3.16 (continued)

Although the language sequences reachable from the states 9 and 10 are the same, these two states cannot be bisimilar, because from 9 we can make a transition with a to the state 11, which has no transitions, but from 10, the only state we can reach is 10, which has a transition labelled with a to this state. This distinction appears when we consider the trees of chains of language trees, which appear in Figures 10, 11, and 12.

The image of \mathcal{A} in the final automaton is represented in Figure 13 (the states which are not image of any state of \mathcal{A} are not shown). Note that the only final state is \mathcal{Q}_4 , because the only language containing ϵ was L_4 , the initial language of \mathcal{Q}_4 . Of course, this also follows from the fact that the final states of \mathcal{A} , 4 and 6, are mapped into \mathcal{Q}_4 . The automaton shown in Figure 13 can be regarded as the smallest simple automaton showing the same state behaviour as \mathcal{A} .

Of course, the subautomaton of \mathcal{A} composed by the states 9, 10 and 11 and the corresponding transitions is enough to show that the trees of language sequences are not enough to describe the final automaton. We have presented this more complicated example to show how to work with alphabets consisting of more than one letter.

Example 3.17. Consider now the automaton given by $S = \{1, 2, 3, 4\}$, $A = \{a\}$, $\delta(1) = \{1, 2, 3, 4\}$, $\delta(2) = \{1, 2, 3\}$, $\delta(3) = \{3, 4\}$, $\delta(4) = \emptyset$, and $S_f = \emptyset$. This automaton is like the one in Example 3.1, but with no final states. Obviously, all states have associated the empty language \emptyset . The trees of languages associated to this automaton are like the ones represented in Figure 5, but with all languages replaced by \emptyset . In this case, only the branching information of the automaton is used. The corresponding images in the final automaton look like the ones represented in Figure 6 with the trees T_i coming from the ones of Figure 5. The automaton is also simple.

This technique of considering non-deterministic automata for a language of one letter and no final states can be used to simulate coalgebras for the finite power-set functor \mathcal{P}_ω . Since all languages are empty, the languages turn out to be irrelevant in our discussion for this kind of automata. This can be compared with the description of infinite trees modulo bisimilarity presented by Barr in [5] or the strongly extensional trees of Worrell in [29], which are recovered with our description.

Remark 3.18. As we have mentioned in Section 3, automata can be regarded as F -realisations in the sense of Kozen [18] for the type signature F of Figure 2. We now outline how to pass from Kozen's description to our description and vice versa. The nodes of the final F -realisation can be regarded as trees like in the example of Figure 14, which corresponds to the image in the final automaton for the alphabet $A = \{a, b, c\}$ of a final state with two

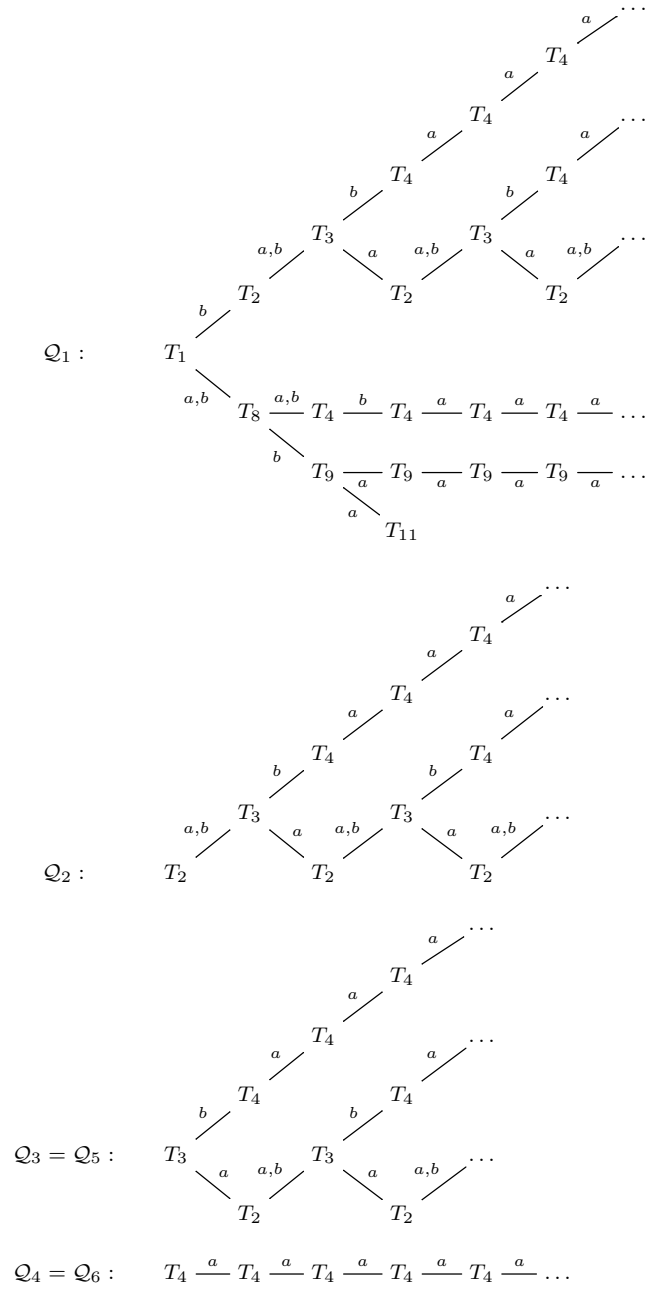

Figure 10: Trees of chains of trees of languages of Example 3.16

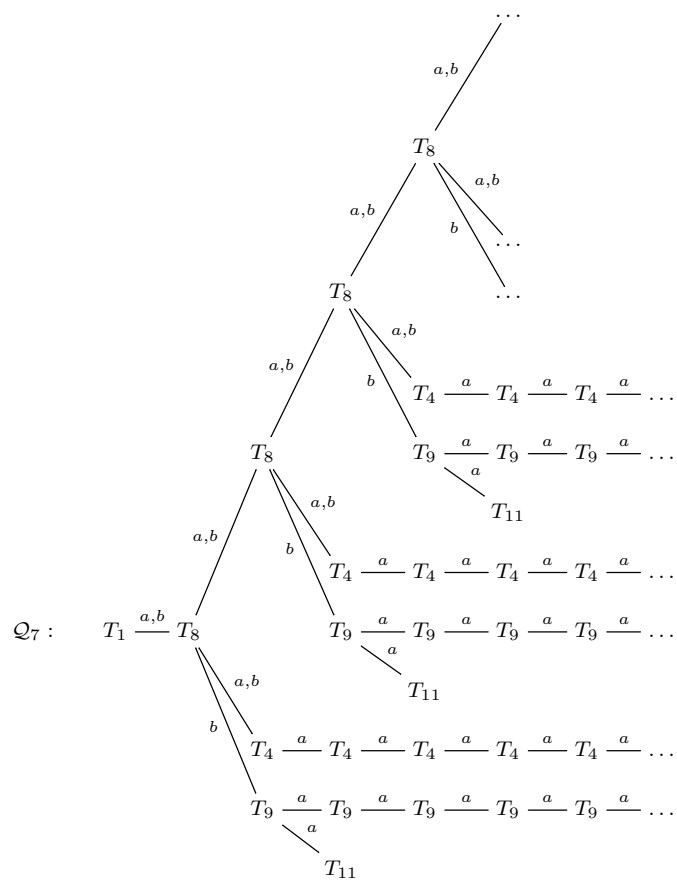

Figure 11: Trees of chains of trees of languages of Example 3.16 (continued)

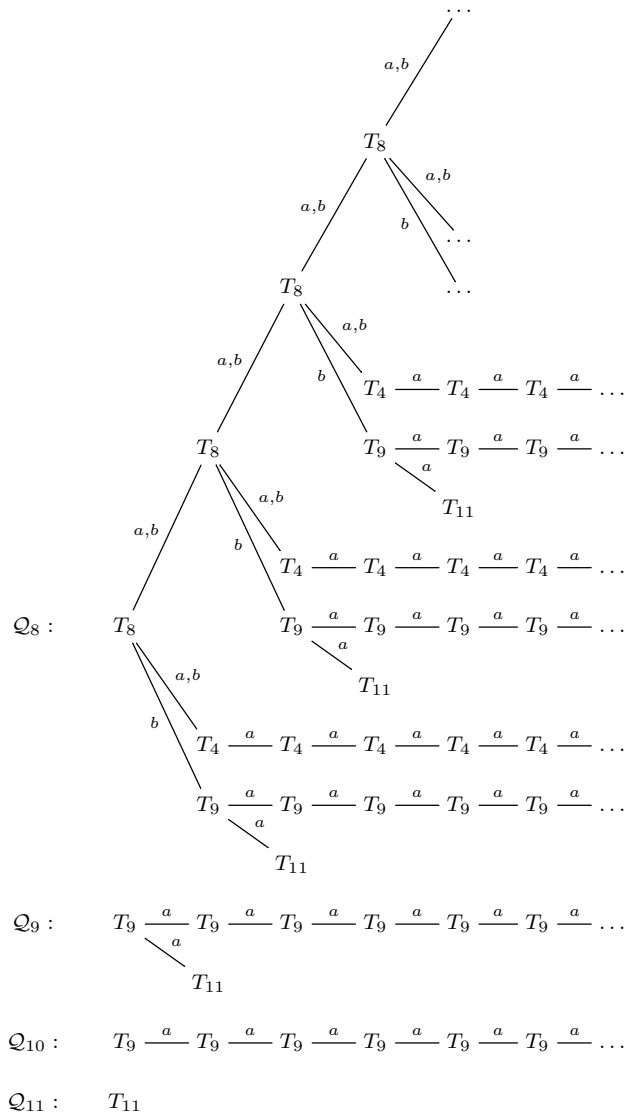

Figure 12: Trees of chains of trees of languages of Example 3.16 (continued)

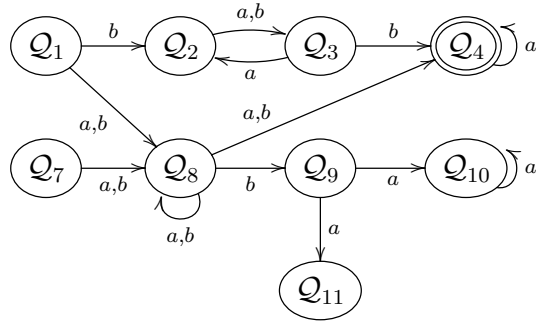

Figure 13: Image of the automaton of Example 3.16 in the final automaton

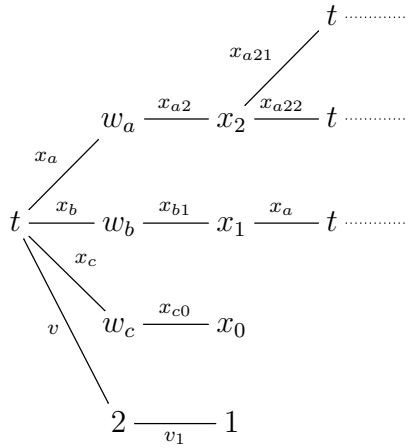

Figure 14: Example of a node of the final realisation for an automaton

transitions labelled by a , a transition labelled by b and no transitions labelled by c . We can associate to this state the language corresponding to all words $a_1 \dots a_k$ such that there exists a path starting with t whose edges are labelled

$$\langle x_{a_1}, x_{a_1 i_1}, x_{a_1 i_1 j_1}, \dots, x_{a_k}, x_{a_k i_k}, x_{a_k i_k j_k}, v, v_1 \rangle.$$

We can generate the corresponding language tree by replacing each t by the corresponding language, the path composed by three edges $\langle x_a, x_{ai}, x_{aij} \rangle$ by a and by deleting the paths composed by the edges $\langle v, v_0 \rangle$ or $\langle v, v_1 \rangle$, as well as the paths composed by the edges $\langle x_a, x_{a0} \rangle$. By substituting each state t by the corresponding language tree, we get the tree of chains of language trees of our construction. Conversely, given a state of the language tree automaton and a letter $a \in A$, we can associate to it the following paths:

- First, the path composed by $\langle v, v_1 \rangle$ if ϵ belongs to its initial language and $\langle v, v_0 \rangle$ otherwise.
- Let $a \in A$.
 - If there are no transitions labelled with a from this state, we simply add the path $\langle x_a, x_{a0} \rangle$.
 - If there are i transitions labelled with a from this state, we assign the paths whose edges have the labels $\langle x_a, x_{ai}, x_{aij} \rangle$, for $1 \leq j \leq i$, followed by all paths corresponding to the images of the transition of this state by a obtained with this method.

The coinduction principle (see Rutten [22]) guarantees that this construction is possible.

4 Discussion and future work

We have obtained a description for the final object in the category of non-deterministic automata in terms of languages. We have also proved that the observational behaviour of an automaton (bisimilarity) can be described in terms of the languages accepted from each state. In our approach, it is just an equality of sets obtained from the languages associated with the states of the automaton. This generalises a known fact for deterministic automata, as the language automaton introduced in the beginning of Section 3 shows, but which did not seem evident for non-deterministic automata as we have seen in Example 3.1. Our structures derive from the branching information of the automata, with the states substituted by their corresponding languages and, in some sense, follow the same ideas of Barr [5] and Worrell [29] about

the branching information. However, even some natural candidates for the states of the final non-deterministic automaton, as the one presented in Example 3.15, based only on the branching information of the automata with the states replaced by their corresponding languages, are not good enough for our purposes.

As we have mentioned, Barr [5] and Worrell [29] have presented a description of final objects in \mathcal{P}_ω -coalgebras by means of suitable infinite trees modulo bisimilarity, which exploit their branching information. However, if we want to describe bisimilarity by means of the final object, this approach is not sufficient, because it could be like a *petitio principii*. A precise description of the relation is achieved in this paper by means of the description of the language tree automaton and the homomorphism from a given automaton to the language tree automaton. Nevertheless, as we have mentioned in the previous section, we obtain trees isomorphic to the strongly extensional trees of Worrell [29] when we use automata to simulate \mathcal{P}_ω -coalgebras.

The description of the language tree automaton is indeed a generalisation of the description of the language automaton. In the case of a deterministic automaton, for each state s and each letter $a \in A$, there exists a unique transition $s \xrightarrow{a} t$ and the corresponding languages satisfy the relation $L_t = a^{-1}L_s$. This property also holds in the language automaton, in which the transitions have the form $L \xrightarrow{a} a^{-1}L$. This implies that the language sequences associated to state sequences in a deterministic automaton are uniquely determined by their initial languages. The same can be affirmed about language trees, chains of language trees, and trees of chains of language trees associated to state sequences of deterministic automata, which are also uniquely determined by their initial languages.

The computation of the image of a non-deterministic automaton in the language tree automaton solves a problem of minimisation of automata by Corollary 3.14. The image of a given automaton is a simple automaton, that is, given two different states, they are not bisimilar. The corresponding minimisation problem for deterministic automata is solved by means of the equality of the languages recognised from the states. Other known algorithms are available to identify bisimilarity and so to construct this image into the final automaton, like state partition algorithms (see, for instance, [1]).

We must observe that our automata are not necessarily finite. In fact, the final automaton is infinite. The same thing happens with the final deterministic automaton, whose states are all languages: it is infinite and non-regular languages can appear as states. However, the set of all states reachable from one state by the action of one letter is kept finite in order to make sure that the states of the final object form a set.

A future research line in this subject could be to apply these techniques to study final coalgebras for other structures which can have languages associated with the states in a natural way. This could be an alternative approach to the descriptions of [5, 6, 7, 18, 25, 27, 29]. For instance, the ideas of Example 3.17 show a possible way to construct the final object for the category of all coalgebras associated with the finite power-set functor.

Another possible future research line could be finding alternative semantics for other structures admitting a coalgebra structure. As an example of what we mean, we might consider the Hennessy-Milner logic. Let $\mathcal{A} = (S, A, S_f, \delta)$ be a non-deterministic automaton. We can define a multi-modal logic $\mathbf{M} = \mathbf{M}_{\mathcal{A}}$ with an atomic proposition p whose semantics is given by set of formulas \mathcal{L} defined by the grammar

$$\phi ::= \mathbf{tt} \mid \neg\phi \mid \phi_1 \wedge \phi_2 \mid \Diamond_a\phi \mid p$$

where a varies over A . This logic is called *Hennessy-Milner logic* because it was introduced by Hennessy and Milner in [13, 14] (see also [28] for more details). The usual interpretation of the formulas is given by the modelling relation $\models \subseteq S \times \mathcal{L}$ defined by

- $s \models \mathbf{tt}$,
- $s \models \phi_1 \wedge \phi_2$ if and only if $s \models \phi_1$ and $s \models \phi_2$,
- $s \models \neg\phi$ if and only if $\neg(s \models \phi)$,
- $s \models \Diamond_a\phi$ if and only if there exists $s' \in \delta(s, a)$ such that $s' \models \phi$,
- $s \models p$ if and only if $s \in S_f$,

The extension of the Hennessy-Milner logic with fixed point operators is the modal μ -calculus. A detailed study of the Hennessy-Milner logic and the modal μ -calculus, as well as bisimilarity and different semantics for them, can be found in [28]. The trees of chains of language trees over A defined from the underlying automaton \mathcal{A} could be used to give an alternative semantics for the Hennessy-Milner logic. We defer the details to a future work.

Acknowledgements

This work has been supported by the grant MTM2010-19938-C03-01 from the *Ministerio de Ciencia e Innovación* (Spanish Government). The first author has been supported by a research project from the National Natural Science Foundation of China (NSFC, No. 11271085). The second author has

been supported by the predoctoral grant AP2010-2764 from the *Ministerio de Educación* (Spanish Government). We also thank Jean-Éric Pin and Jan Rutten for their helpful comments. Finally, we are indebted to the anonymous referees for their careful reading of the paper and for bringing to our attention some references we had missed. Their suggestions have helped us to improve the presentation of the paper.

References

- [1] L. Aceto, A. Ingólfssdóttir, and J. Srba. The algorithmics of bisimilarity. In Sangiorgi and Rutten [24], chapter 3, pages 100–172.
- [2] J. Adámek. Introduction to coalgebra. *Theory Appl. Categ.*, 14(8):157–199, 2005.
- [3] J. Adámek, F. Bonchi, M. Hülsbusch, B. König, S. Milius, and A. Silva. A coalgebraic perspective on minimization and determinization. In L. Birkedal, editor, *Foundations of Software Science and Computational Structures. 15th International Conference, FOSSACS 2012 held as part of the European Joint Conferences on Theory and Practice of Software ETAPS 2012. Proceedings*, volume 7213 of *Lecture Notes in Computer Science*, pages 58–73, Berlin Heidelberg, 2012. Springer.
- [4] J. Adámek, S. Milius, L. S. Moss, and L. Sousa. Power-set functors and saturated trees. In Marc Bezem, editor, *Computer Science Logic (CSL'11) - 25th International Workshop/20th Annual Conference of the EACSL*, volume 12 of *Leibniz International Proceedings in Informatics (LIPIcs)*, pages 5–19, Dagstuhl, Germany, 2011. Schloss Dagstuhl–Leibniz-Zentrum für Informatik.
- [5] M. Barr. Terminal coalgebras in well-founded set theory. *Theoret. Comput. Sci.*, 114(2):299–315, 1993.
- [6] M. M. Bonsangue, J. J. M. M. Rutten, and A. Silva. Coalgebraic logic and synthesis of Mealy machines. In R. M. Amadio, editor, *FoSSaCS08*, volume 4962 of *Lecture Notes in Computer Science*, pages 231–245. Springer, 2008.
- [7] M. M. Bonsangue, J. J. M. M. Rutten, and A. Silva. An algebra for Kripke polynomial coalgebras. In A. Pitts, editor, *LICS 2009*, volume 5504 of *Lecture Notes in Computer Science*, pages 49–58. IEEE Computer Society, 2009.

- [8] J. Brzozowski. Derivatives of regular expressions. *J. ACM*, 11(4):481–494, 1964.
- [9] J. Brzozowski and H. Tamm. Theory of átomata. In G. Mauri and A. Leporati, editors, *Developments in Language Theory. 15th International Conference, DLT 2011, Milan, Italy, July 19–22, 2011. Proceedings*, volume 6795 of *Lecture Notes in Computer Science*, pages 105–116. Springer, 2011.
- [10] M. Delgado, S. Linton, and J. J. Morais. *Automata (version 1.13)*, 2004. <http://cmup.fc.up.pt/cmup/mdelgado/automata/>.
- [11] The GAP Group. *GAP – Groups, Algorithms, and Programming, Version 4.5.7*, 2012.
- [12] H.-P. Gumm and T. Schröder. Coalgebraic structure from weak limit preserving functors. *Electron. Notes Theor. Comput. Sci.*, 33:111–131, 2000.
- [13] M. Hennessy and R. Milner. On observing nondeterminism and concurrency. *Lecture Notes in Computer Science*, 85:295–309, 1980.
- [14] M. Hennessy and R. Milner. Algebraic laws for nondeterminism and concurrency. *J. ACM*, 32:137–162, 1985.
- [15] J. E. Hopcroft, R. Motwani, and J. D. Ullman. *Introduction to Automata Theory, Languages, and Computation*. Pearson/Addison Wesley, 2007.
- [16] B. Jacobs and J. Rutten. A tutorial on (co)algebras and (co)induction. *Bull. EATCS*, 62:222–259, 1997.
- [17] A. Joyal, M. Nielsen, and G. Winskel. Bisimulation from open maps. *Inform. and Comput.*, 127(2):164–185, 1996.
- [18] D. Kozen. Realization of coinductive types. *Electron. Notes Theor. Comput. Sci.*, 276:237–246, 2011.
- [19] J. Lambek. A fixpoint theorem for complete categories. *Math. Z.*, 103:151–161, 1968.
- [20] S. Mac Lane. *Categories for the Working Mathematician*, volume 5 of *Graduate Texts in Mathematics*. Springer-Verlag, New York-Heidelberg-Berlin, second edition, 1998.

- [21] J. J. M. M. Rutten. Automata and coinduction (an exercise in coalgebra). In D. Sangiorgi and R. de Simone, editors, *CONCUR'98*, volume 1466 of *Lecture Notes in Computer Science*, pages 194–218, Berlin, Heidelberg, 1998. Springer-Verlag.
- [22] J. J. M. M. Rutten. Universal coalgebra: a theory of systems. *Theoret. Comput. Sci.*, 249:3–80, 2000.
- [23] J. J. M. M. Rutten and D. Turi. On the foundations of final semantics: non-standard sets, metric spaces, partial orders. In J. W. de Bakker, W.-P. de Roever, and G. Rozenberg, editors, *Proceedings REX Workshop on Semantics*, volume 666 of *Lecture Notes in Computer Science*, pages 477–530, Berlin, 1993. Springer.
- [24] D. Sangiorgi and J. Rutten, editors. *Advanced Topics in Bisimulation and Coinduction*, volume 52 of *Cambridge Tracts in Theoretical Computer Science*. Cambridge Univ. Press, Cambridge, 2012.
- [25] A. Silva. *Kleene coalgebra*. PhD thesis, Radboud Universiteit Nijmegen, December 2010.
- [26] A. Silva, F. Bonchi, M. Bonsangue, and J. Rutten. Generalizing determinization from automata to coalgebras. *Log. Meth. Comput. Sci.*, 9(1:09):1–27, 2013.
- [27] A. Silva, M. M. Bonsangue, and J. J. M. M. Rutten. Non-deterministic Kleene coalgebra. *Log. Meth. Comput. Sci.*, 6(3):23/1–39, 2010.
- [28] C. Stirling. Bisimulation and logic. In Sangiorgi and Rutten [24], chapter 4, pages 173–196.
- [29] J. Worrell. On the final sequence of a finitary set functor. *Theoret. Comput. Sci.*, 338:184–199, 2005.